

ASKO



Instructions for use

Cooker hood

CC4525S / 4000

Pictograms used :



Important information



Tip

CONTENT

Your canopy hood

Description	4
Introduction	4

Use

Controls	5
----------	---

Maintenance

Cleaning	7
Removing the grease filters	8
Replacing the carbon filter	8
Changing the light bulbs	8

Installation

General	9
Electrical connection	10
Mounting the canopy hood	11

Technical specifications

12

Appendice

Disposal of appliance and packaging	13
-------------------------------------	----

YOUR CANOPY HOOD

Description

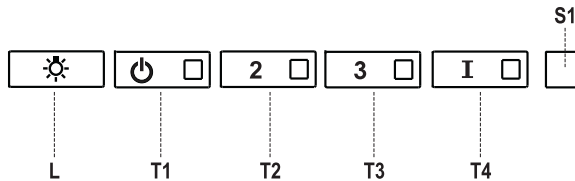

- L** Switch lighting on/off
- T1** Switch on/off + fan speed 1
- T2** Switch on fan speed 2/switch on carbon filter indicator
- T3** Switch on fan speed 3/reset grease filter indicator
- T4** Switch on intensive setting
- S1** Filter indicator

Introduction

This user manual gives you a quick overview of all the possibilities offered by the appliance. You will find information on safety measures and maintaining the appliance.



*Please retain this user manual and the installation guide.
They may be of use to future users of the appliance.*

Declaration of conformity

We declare that our products meet the applicable European Directives, Decisions and Regulations and the requirements listed in the standards referenced.



Read the separate safety instructions before using the device!

Controls

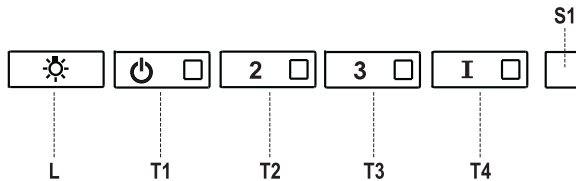

Switching the fan on and off

- Use the On/Off button (T1) to switch on the fan and select the extractor setting desired with the 'T2', 'T3' or 'T4' buttons.
The LED indication on the buttons shows which setting has been selected.
- Use the 'T4' button to switch on the intensive setting.
- The intensive setting switches off automatically after 6 minutes.
After these 6 minutes the speed is reduced to the setting previously selected.

Switch the lighting on and off

- Use the 'L' button to switch the lighting on and off.

Grease filter indication

- The 'S1' indicator light switches on when the grease filter needs to be cleaned.
- The indicator light switches on after the extractor hood has been in use for 100 hours. This is to indicate that the grease filter needs to be cleaned.
- Press and hold the 'T3' button for 3 seconds to reset the indication.
The 'S1' indicator light flashes 3 times to confirm that the setting has been reset.

Carbon filter indicator

- Press and hold the 'T2' button for 3 seconds
- to activate the carbon filter contamination indication.
The LED indication on the 'T2' button flashes 2 times in confirmation.
- After the extractor hood has been in use for 200 hours with the carbon filter contamination indication activated, the 'S1' indicator light starts to flash. This indicates that the carbon filter needs to be replaced.
- Press and hold the 'T2' button again for 3 seconds to switch off the alarm.
The LED indication on the 'T2' button flashes 1 time in confirmation.

Cleaning



Attention! Before performing any maintenance operation, isolate the hood from the electrical supply by switching off at the connector and removing the connector fuse. Or if the appliance has been connected through a plug and socket, then the plug must be removed from the socket.

The cooker hood should be cleaned regularly (at least with the same frequency with which you carry out maintenance of the fat filters) internally and externally. Do not use abrasive products. **Do not use alcohol!**

Attention! Failure to carry out the basic cleaning recommendations of the cooker hood and replacement of the filters may cause fire risks. Therefore, we recommend observing these instructions. The manufacturer declines all responsibility for any damage to the motor or any fire damage linked to inappropriate maintenance or failure to observe the above safety recommendations.

Cooker hood

Clean the cooker hood with soapy water and a soft cloth. Then wipe with clean water to rinse. Do not use aggressive cleaning agents such as soda. The cooker hood paintwork will stay looking nice if you wax it occasionally.



Stainless steel canopy hoods

Do not use any sort of scourer. Treat with a stainless steel care product and polish with the structure of the stainless steel.

Metal grease filters

These must be cleaned once a month (or when the filter saturation indication system – if envisaged on the model in possession – indicates this necessity) using non aggressive detergents, either by hand or in the dishwasher, which must be set to a low temperature and a short cycle. The openings must be placed downwards to let the water run out of the filters. The cleaning agents will make the aluminium filter turn dull, this is normal.

MAINTENANCE

Grease filters

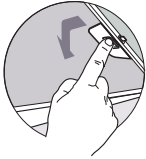

Removing the grease filters

Switch off the electricity! Remove the plug from the socket or switch the electricity off at the mains. Open the panel and pull the special handle to remove the filter.

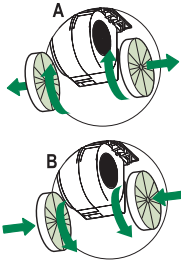

Replacing the carbon filter

The carbon filter must always be used if the cooker hood is not ducted.

1. Open the panel.
2. Remove the grease filters.
3. Fit the carbon filter by wedging it into the casing (B).
4. Replace the filter grids in the extractor hood.

Note:

- Saturation of the activated charcoal will eventually occur after more or less prolonged use, depending on the type of cooking and how frequently the grease filter is cleaned.
- In all cases it is necessary to replace the cartridge at least every four months.
- DO NOT wash or reuse the carbon filter. Saturated carbon is not environmentally friendly, change the filter regularly.

Lighting



Changing the light bulbs

Faulty LEDs must be replaced by a professional installer.

General

This appliance should be connected to the power supply by a recognized fitter who is familiar with, and works according to the correct safety regulations. This appliance meets the European requirements.

Important that you know:

- The minimum distance between the supporting surface for the cooking vessels on the gashob and the lowest part of the range hood must be not less than 65 cm. For use with an electric, ceramic or induction hob, this distance must be at least 50 cm.
- If the cooker hood is to be fitted to an existing duct no other appliances, such as a geyser or heater, may be connected to that same duct.
- Consider local regulations with respect to the ventilation of gas appliances.
- The shorter the duct, and the fewer the bends in it, the better the cooker hood will work.
- Before you start drilling check that there are no installation cables present.
- The connecting pipe for the cooker hood has a diameter of 120 or 150 mm. It is best also to use a flue pipe of the same diameter.
- The installation material supplied with this range hood is designed for fixing to reinforced concrete or masonry walls. For some types of walls you may need special plugs and screws.

INSTALLATION

Electrical connection

This appliance is manufactured in class I, it must therefore be connected to the earth system.

Make sure the supply voltage ratings correspond with those stated on the appliance data plate. The connection to the mains is carried out as follows:

BROWN = phase L

BLUE = phase N

YELLOW/GREEN = Earth

During the electrical connection make sure that the electrical socket is equipped with earth connection.

This canopy hood has been provided with a power plug. When installing the hood, make sure that this plug remains accessible.



Attention:

If you want to make a fixed connection, ensure that a multi-pole switch with a distance between contacts of 3 mm is installed in the supply cable.

max. 100 cm

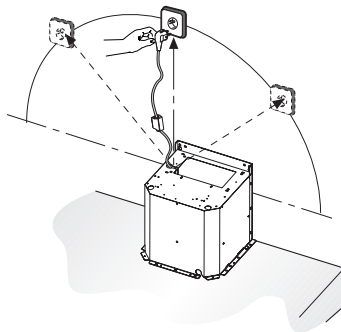

INSTALLATION

Montage

- Open the panel.

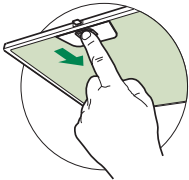
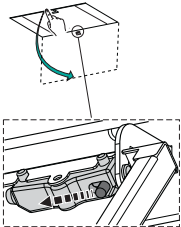

- Remove the grease filter.
- Interrupt the plug connection of the controls.



- First remove the 6 screws, followed by the frame.

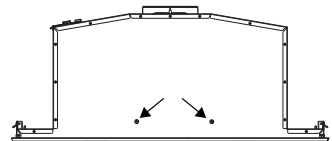
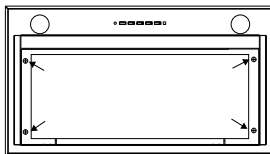

- Use a saw to create a recess in the bottom side of the cupboard (at a distance of at least 650 mm from a gas hob). Refer to the measurement drawing for this.
- Attach the unit with the 10 screws provided (12a).
- Put the frame into position with the 6 screws.
- Restore the plug connection of the controls.
- Put the grease filter into position and close the panel.

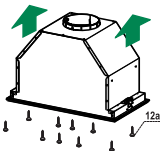
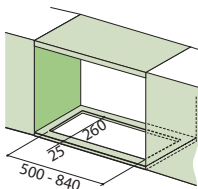

TECHNICAL SPECIFICATIONS

Hood type	CC4525S
Type / Approval	Built in hood 4000
Control type	Electronic push buttons
Width	60
Supply (Voltage, frequency)	220~240 V / 50 Hz
Power	277
Power motor	275
Power lights (W)	2 x LED 1W
Level 1	330 m ³ /h, 53 dB(A), 320 Pa
Air flow, Noise, Pressure	
Level 2	500 m ³ /h, 64 dB(A), 420 Pa
Air flow, Noise, Pressure	
Level 3	575 m ³ /h, 67 dB(A), 440 Pa
Air flow, Noise, Pressure	
Level 4	680 m ³ /h, 72 dB(A), 490 Pa
Air flow, Noise, Pressure	

Disposal

Disposal of appliance and packaging

By ensuring this product is disposed of correctly, you will help prevent potential negative consequences for the environment and human health, which could otherwise be caused by inappropriate waste handling of this product. The local authorities can provide you with the relevant information.

The packaging of this appliance is recyclable. It could have been made from:

- cardboard;
- polythene foil (PE);
- CFK-free polystyrene (PS-hard foam).

You need to dispose of these materials responsibly in accordance with official regulations.

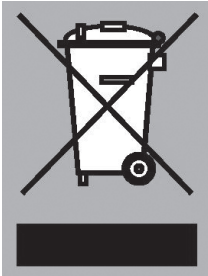

To draw attention to the fact that the segregated processing of electric household appliances is compulsory, this appliance carries the symbol of a crossed-out dustbin. This means that at the end of its working life, you may not dispose of the appliance as household refuse. Instead, you should hand it in at a special refuse collection centre run by the local authority or at a dealer's providing this service.

Segregated processing of household appliances avoids any negative effects on the environment and public health that might otherwise occur.

It enables the recovery of the materials used in the production of this appliance, thus realising considerable savings in terms of raw materials and energy.

Declaration of conformity

We hereby declare that our products satisfy the applicable European directives, orders and regulations, as well as the requirements stated in the referenced standards.



 **ASKO**



566263